

BUY NOW 

100kHz Driver for NanoSpeed™ Variable Optic Attenuator (Preliminary)

(patents pending)

Product Description

This NS series of fast-speed driver is designed to control NS series of solid state variable optic attenuators (VOA). The push-pull output design is especially suitable for driving capacitive VOA loads, assuring the fast response time both on rising and falling of attenuation. The driver can be operated by 0-5V signal to control the attenuation of VOA.

The standard driver controls one individual VOA. Drivers controlling multiple VOAs are also available, please call Sales at (781) 935-1200 for more information.

Features

- Fast response
- High repetition rate
- Push-Pull output design
- Low quiescent power consumption

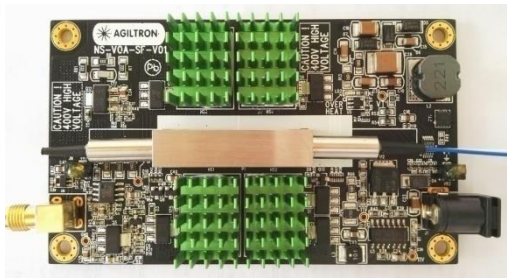
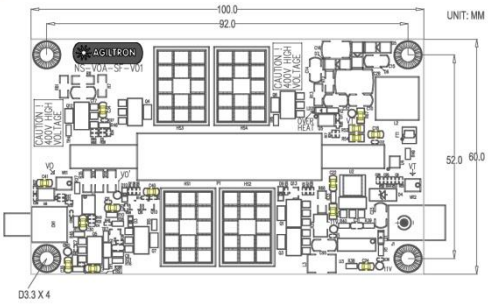

Performance Specifications

Technical Specs	Min	Typical	Max	Unit
Response time (Rise) (Sr) [1]	250		850	ns
Response time (Fall) (Sf) [2]	250		850	ns
Repetition Rate	DC		100	kHz
Control signal for attenuation	0		5[3]	V
Power Consumption [4]			8	W
Power Supply	12		24	V
Operating Temperature	-5		70	°C
Storage Temperature	-40		80	°C
Electrical Connector	SMA			
Board Size	3.94(L)x2.36(W)x0.06(H)			Inch

Note:
 [1]: Response time (Rise): Begin of electronic signal to the completion of optic intensity change
 [2]: Response time (Fall): Begin of electronic signal to the completion of optic intensity change.
 [3]: For full attenuation in VOA
 [4]: Dependent on repetition frequency. Measured for the attenuation > 20dB at 100 kHz.

Applications

- NS-VOA
- Optical Modulator
- Variable beam splitter

DC-100KHz Driver for NanoSpeed™ VOA

Response Time

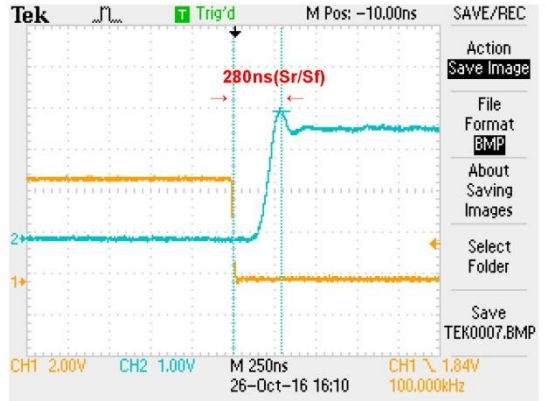
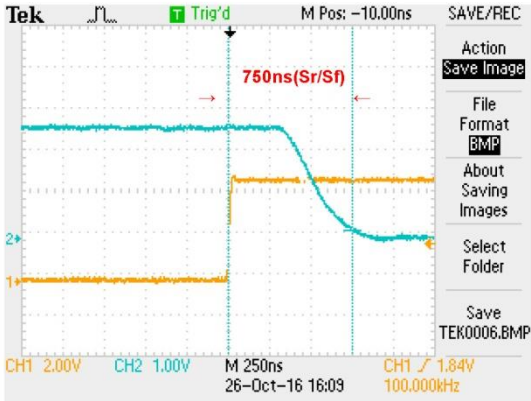

Power Consumption

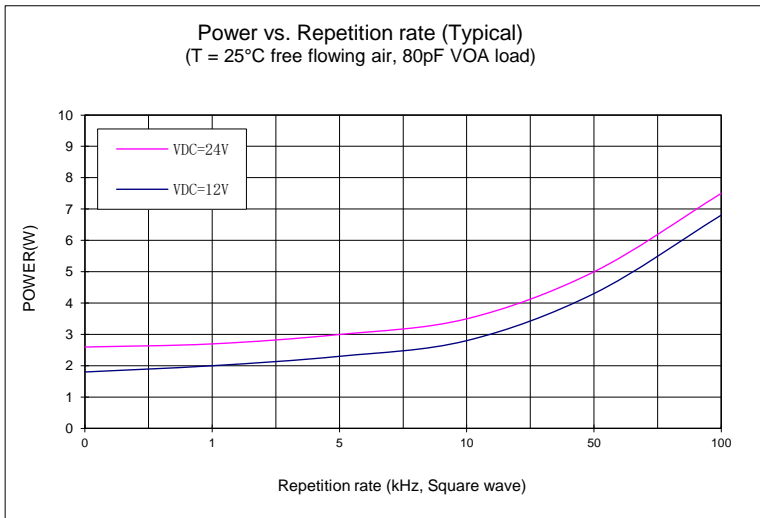

Ordering Information

Prefix	Type	Repetition	Size	# of VOA	Connector
NVDR-	1 1	DC-100KHz = 2 Special = 0	3.9"x2.4"x0.6" = 2 Special = 0	Single VOA = 11 Special = 00	SMA = 2 Special = 0

*Product dimensions may change without notice. This is sometimes required for non-standard specifications.

DC-100KHz Driver for NanoSpeed™ VOA

Power Connector

P/N: SC1313-ND
 Power Barrel Connector Jack 2.00mm ID (0.079"),
 5.50mm OD (0.217") Through Hole, Right Angle

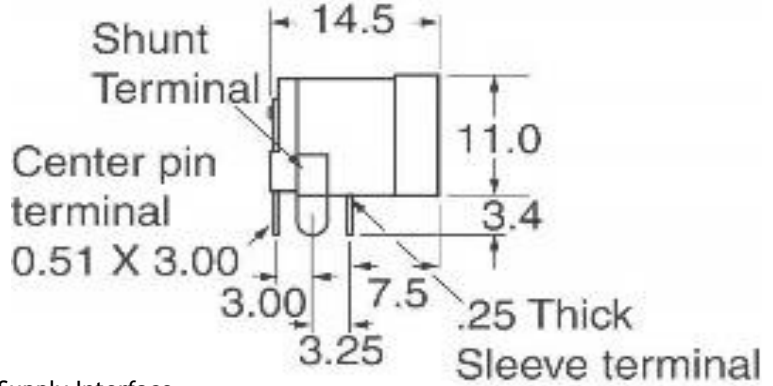

12V Wall Plug DC Power Supply Interface

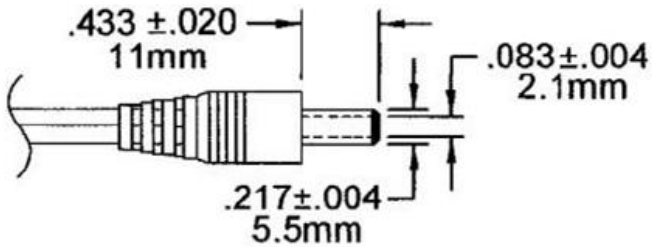

*Product dimensions may change without notice. This is sometimes required for non-standard specifications.

DC-100KHz Driver for NanoSpeed™ VOA

Typical Operation Instructions

1. Connect a control signal to the SMA connector on the PCB
2. Attach the accompanied power supply (typically a wall-pluggable unit).
3. The device should then function properly.

Note: Do not alter device factory settings.