

MEMS 1x4 Fiber Optic Switch >70dB Crosstalk

(Bidirectional, SM, PM)

(Protected by U.S. pending patents)



DATASHEET

BUY NOW

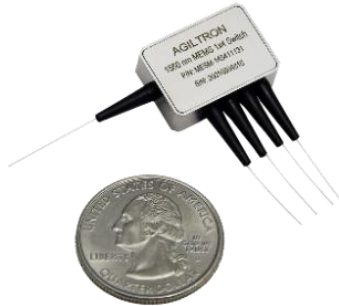

The MEMS 1x4 Series Fiber Optic Switch uses a patented thermal activated micro-mirror, moving-in and -out optical paths at a 45-degree angle to direct an incoming light into a selected output fiber without hitting other ports, by which the degradation of multi-fiber collimator due to the laser steering in long period is entirely eliminated. It uniquely offers unprecedented high stability over a wide temperature range, compact size, exceptionally long operation life, insensitivity to moisture and ESD, no short- and long-term drifts, and high reliability for over 25 years of continuous operation.

The device can also simultaneously function as a variable attenuator, continuously controlling the output light intensity. The switches are Telcordia GR1221 qualified. The switch is conveniently controlled by directly applying a voltage to each mirror actuator.

Applications

- Channel Blocking
- Add/Drop
- System Monitoring
- Instrumentation

Features

- Hitless
- High Reliability
- Compact Size
- ESD Tolerance

Specifications

Parameter	Min	Typical	Max	Unit
Operation Wavelength		1260~1620		nm
Insertion Loss ^[1]	0.6	0.7	1.3	dB
Wavelength Dependent Loss		0.15	0.3 ^[2]	dB
Polarization Dependent Loss (SM)			0.1	dB
Extinction Ratio (PM)	18			dB
Cross Talk ^[1]	65	70	80	dB
Return Loss ^[1]	50			W
Switching Time		10		ms
Repeatability			± 0.05	dB
Repetition Rate		10		Hz
Durability	10 ¹⁰			cycle
Switching Type		Non-Latching		
Operating Temperature	-5		70	°C
Storage Temperature	-40		85	°C
Optical Power Handling (CW)		300	500	mW

Notes:

[1]. Exclude connectors.

Legal notices: All product information is believed to be accurate and is subject to change without notice. Information contained herein shall legally bind Agiltron only if it is specifically incorporated into the terms and conditions of a sales agreement. Some specific combinations of options may not be available. The user assumes all risks and liability whatsoever in connection with the use of a product or its application.

Rev 02/07/24

© Photonwares Corporation

P +1 781-935-1200

E sales@photonwares.com

W www.agiltron.com

Information contained herein is deemed to be reliable and accurate as of the issue date. Photonwares reserves the right to change the design or specifications at any time without notice. Agiltron is a registered trademark of Photonwares Corporation in the U.S. and other countries.

MEMS 1x4 Fiber Optic Switch >70dB Crosstalk

(Bidirectional, SM, PM)

(Protected by U.S. pending patents)



DATASHEET

Mechanical Footprint Dimensions (mm)

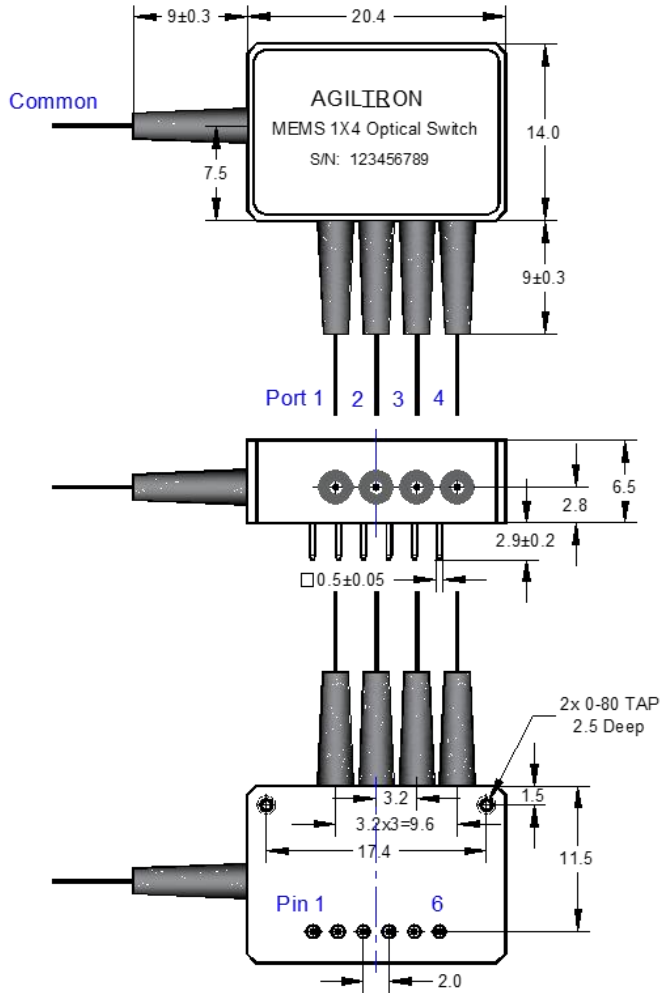

*Product dimensions may change without notice. This is sometimes required for non-standard specifications.

Electronic Control Requirements

Optical Path	Pin Number					
	1	2	3	4	5	6
Common ↔ Port 1	+V	0	0	0	0	0
Common ↔ Port 2	0		+V	0		0
Common ↔ Port 3	0		0	+V		0
Common ↔ Port 4	0		0	0		+V

[1]. +V: 4.0 - 4.4VDC, typically 4.2VDC.

[2]. Each MEMS Chip Power Consumption is about 170 mW.

MEMS 1x4 Fiber Optic Switch >70dB Crosstalk

(Bidirectional, SM, PM)

(Protected by U.S. pending patents)



DATASHEET

Functional Diagram

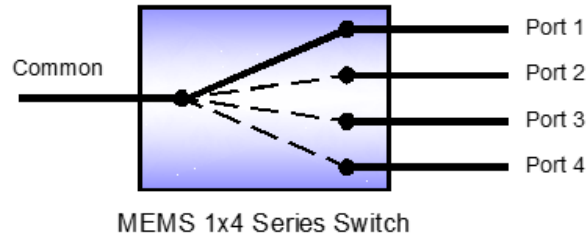

Note:

- 1) Standard version: None of ports is connected optically without voltage. In addition of On-Off operation, the attenuation can be realized in each port. When the applied voltage is increased, IL of the relevant port will be reduced from IL in max (>50dB) to IL in min (<1.0dB), realizing VOA function.
- 2) Default version: Port #4 is connected as default without voltage. VOA function isn't available any more in all ports.

Recommendation Control Circuit

In order to minimize the overshooting and oscillation in optics, the following circuit is recommended for driving signal on PIN.

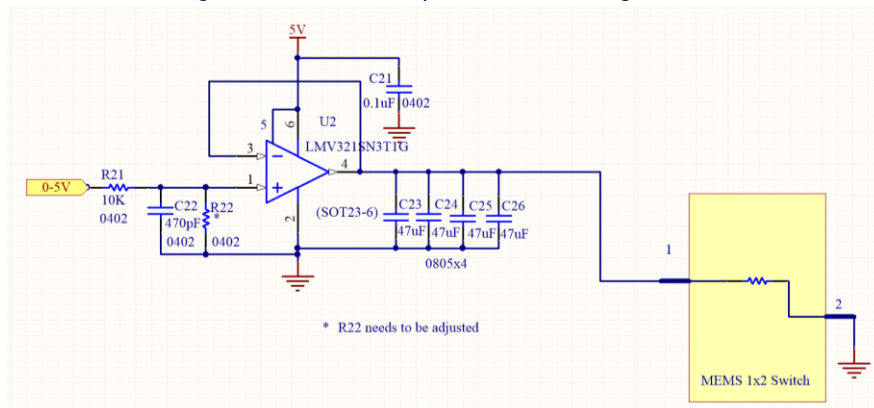

MEMS 1x4 Fiber Optic Switch >70dB Crosstalk

(Bidirectional, SM, PM)

(Protected by U.S. pending patents)



DATASHEET

Ordering Information (Part Number)

Prefix	Type	Wavelength	Switch	Version	Fiber Type	Fiber Cover	Fiber Length	Connector ^[1]
MESM-	1x3 = 13 1x4 = 14 Special = 00	1260~1620 = B 1060 = 1 1310 = 3 1550 = 5 780 = 7 850 = 8 1310/1550 = 9 Special = 0	Non-Latching = 2	Hi Crosstalk= H Special = 0	SMF-28 = 1 PM1550 = B PM1400 = C PM1310 = D PM980 = E PM850 = F Special = 0	0.9mm tube =3 Bare fiber = 1 Special = 0	0.25m = 1 0.5m = 2 1.0m = 3 Special = 0	None = 1 FC/PC = 2 FC/APC = 3 SC/PC = 4 SC/APC = 5 LC/PC = 7 Duplex LC/PC = 8 LC/APC = A LC/UPC = U Special = 0

NOTE:

PM1550 fiber works well for **1310nm**

[1]. The connector cannot be installed directly onto bare fiber, as it is prone to damage during shipping. However, the connector can be assembled on bare fiber if a 3 cm protective loose tube is added for reinforcement. The customer can remove this protective tube after testing. The optical power handling of a standard connector is less than 0.5 W for SM28 fiber and decreases further with smaller core fibers.

Application Notes

Fiber Core Alignment

Note that the minimum attenuation for these devices depends on excellent core-to-core alignment when the connectors are mated. This is crucial for shorter wavelengths with smaller fiber core diameters that can increase the loss of many decibels above the specification if they are not perfectly aligned. Different vendors' connectors may not mate well with each other, especially for angled APC.

Fiber Cleanliness

Fibers with smaller core diameters (<5 μm) must be kept extremely clean, contamination at fiber-fiber interfaces, combined with the high optical power density, can lead to significant optical damage. This type of damage usually requires re-polishing or replacement of the connector.

Maximum Optical Input Power

Due to their small fiber core diameters for short wavelength and high photon energies, the damage thresholds for device is substantially reduced than the common 1550nm fiber. To avoid damage to the exposed fiber end faces and internal components, the optical input power should never exceed 20 mW for wavelengths shorter 650nm. We produce a special version to increase the how handling by expanding the core side at the fiber ends.

MEMS 1x4 Fiber Optic Switch >70dB Crosstalk

(Bidirectional, SM, PM)

(Protected by U.S. pending patents)



DATASHEET

10⁹ Switching Cycle Test

We have tested MEMS 1x2 switch at the resonant frequency ~300Hz for more than 40 days, as shown in the attachment, which corresponding over 10⁹ switching cycles. The measurements show little changes in Insertion loss, Cross Talk, Return loss ect, all parameters are within our specs.

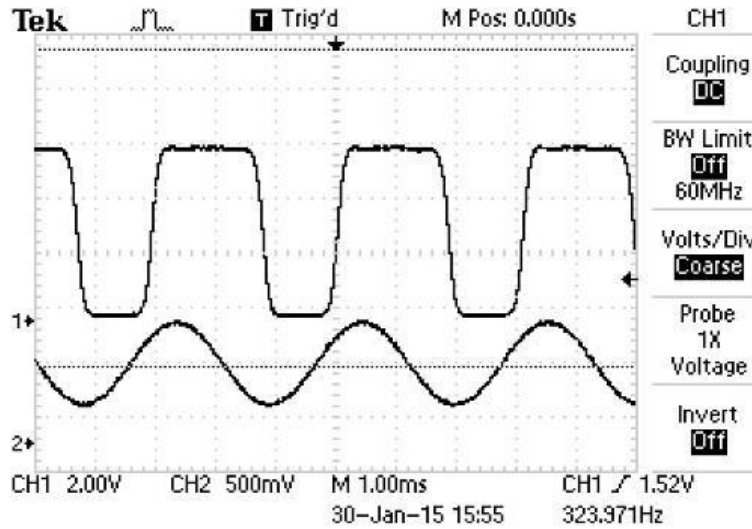

VOA Capability on Port

The attenuation in each channel can be realized in this MEMS switch without scarfying the switch performances. The attenuation is realized by the applied voltage between 0 and 4V, as shown in the following figure (typical).

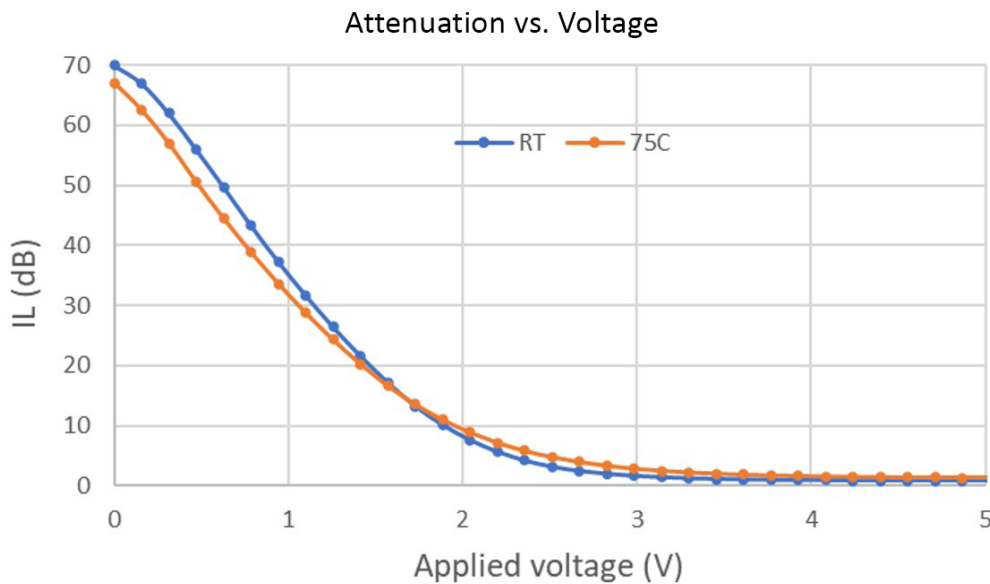

MEMS 1x4 Fiber Optic Switch >70dB Crosstalk

(Bidirectional, SM, PM)

(Protected by U.S. pending patents)



DATASHEET

Typical Insertion Loss vs Wavelength (1240-1630nm)

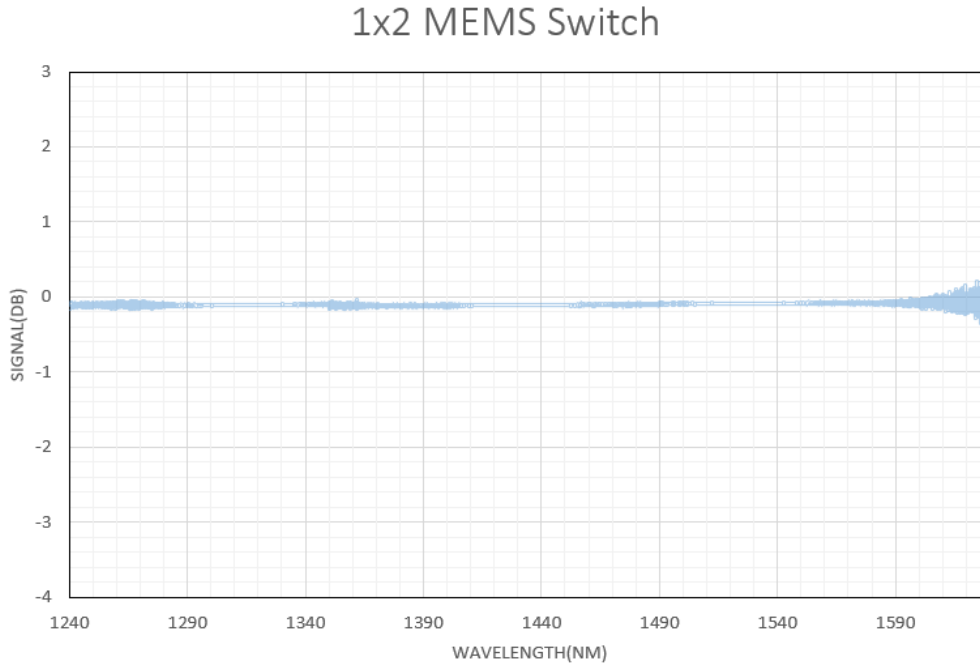

Demo Driver

USB RS232/GUI, Pushbutton/LED Channel Indicators
Applicable to Non-latching MEMS-1x4, 1x8, 1x12 and 1x16 (\$255)

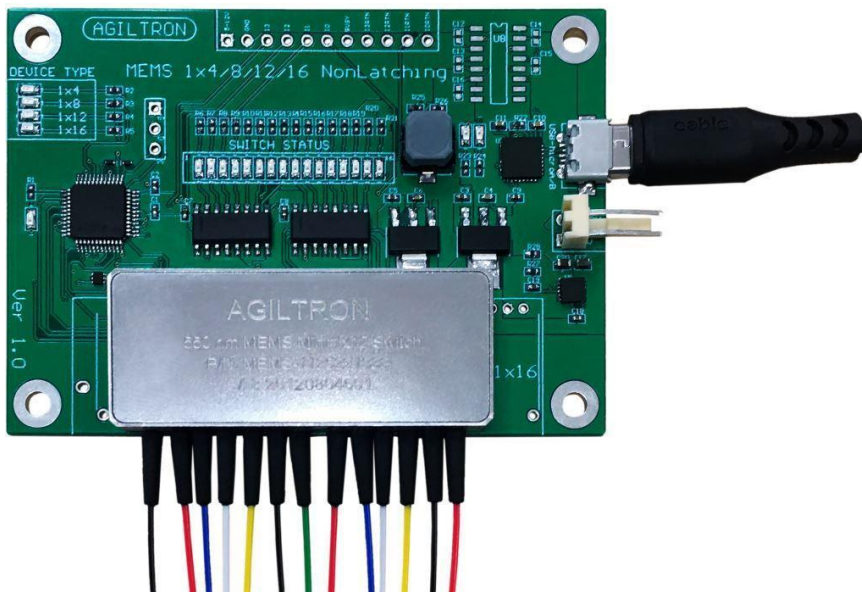

MEMS-1x12 on Demo driver